

TUV 认证 证书编号: B 10

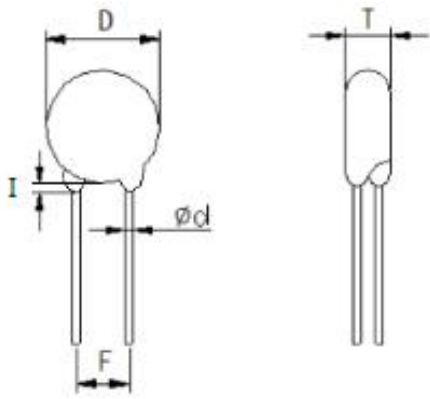







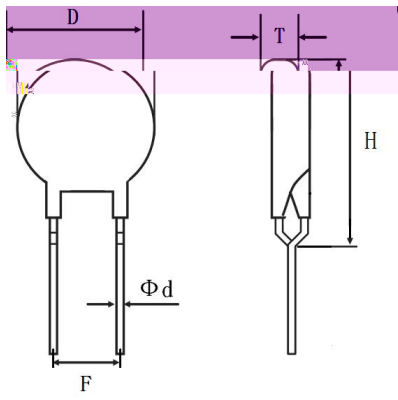

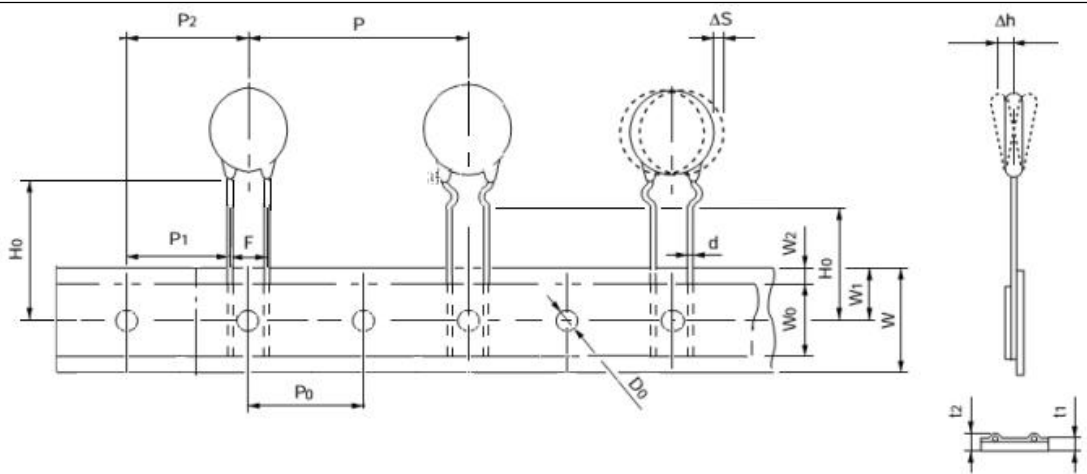
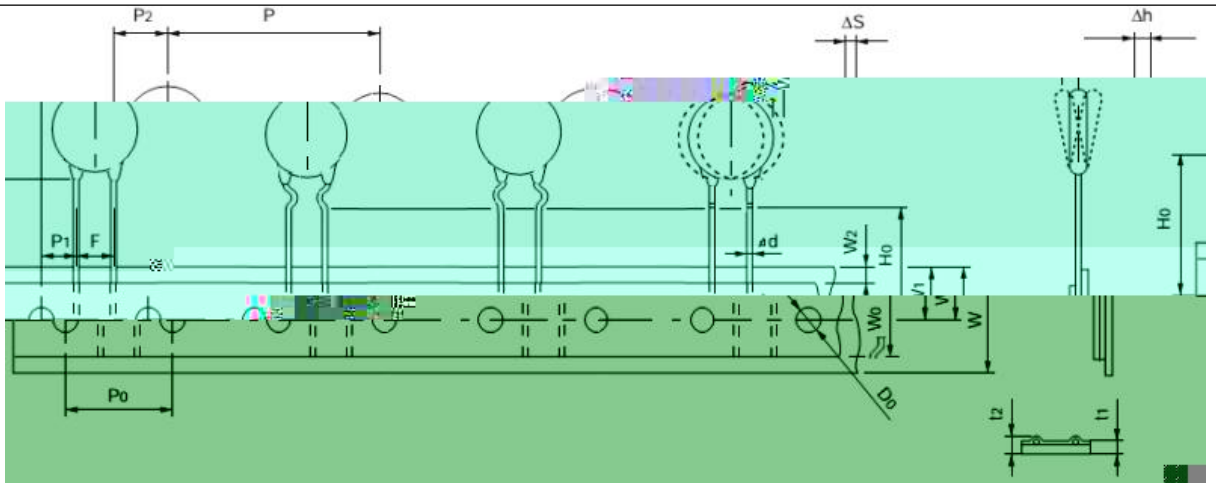

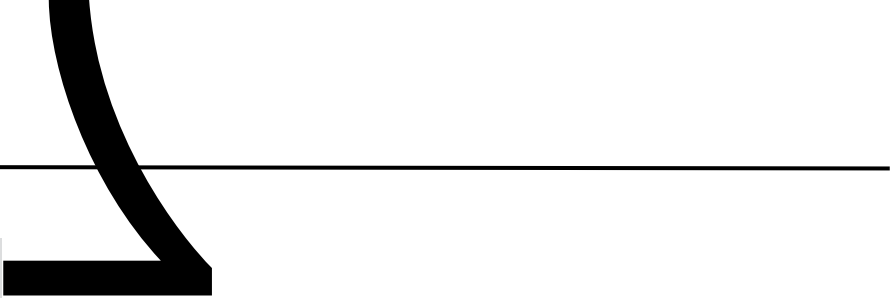
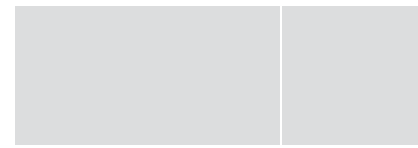

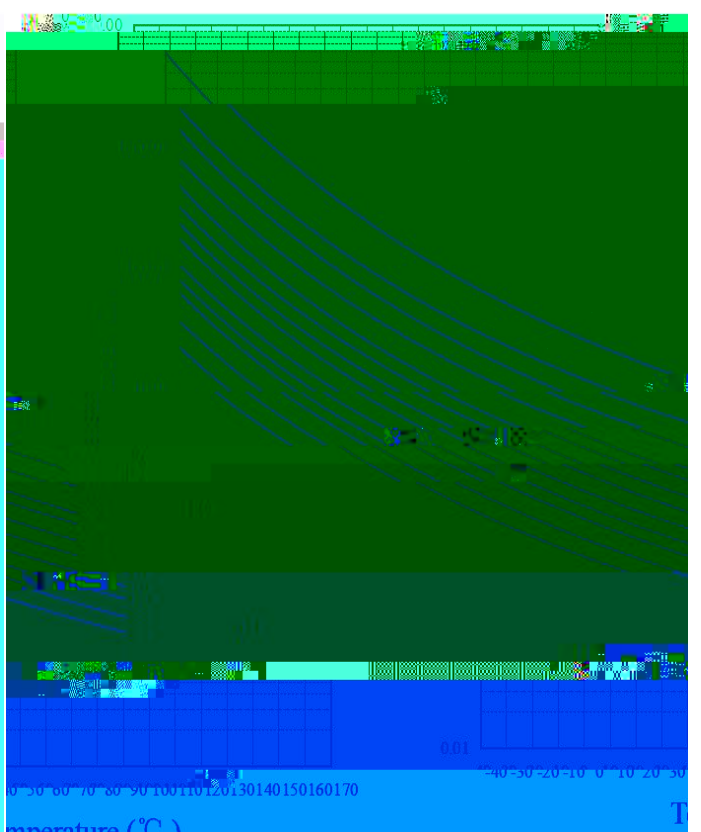
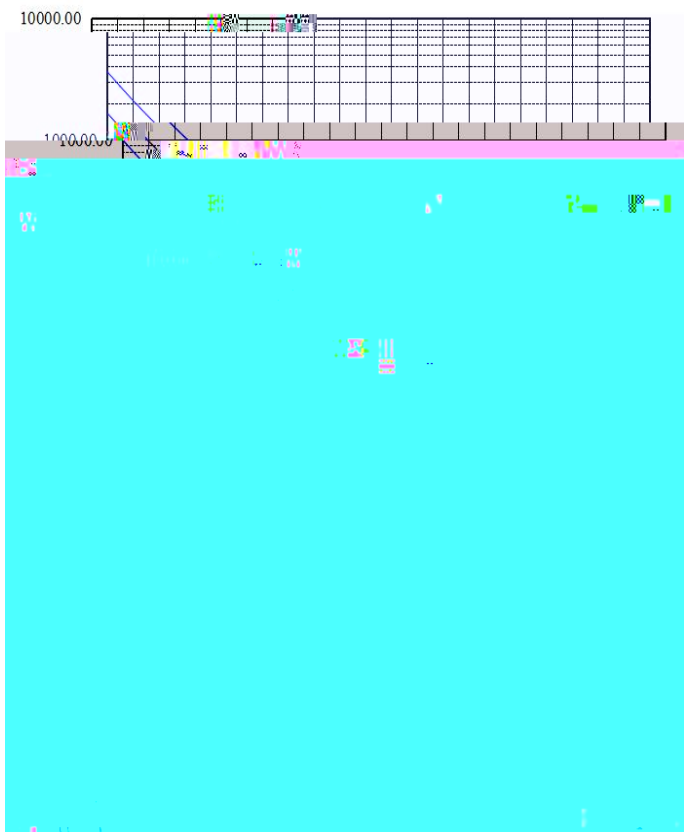
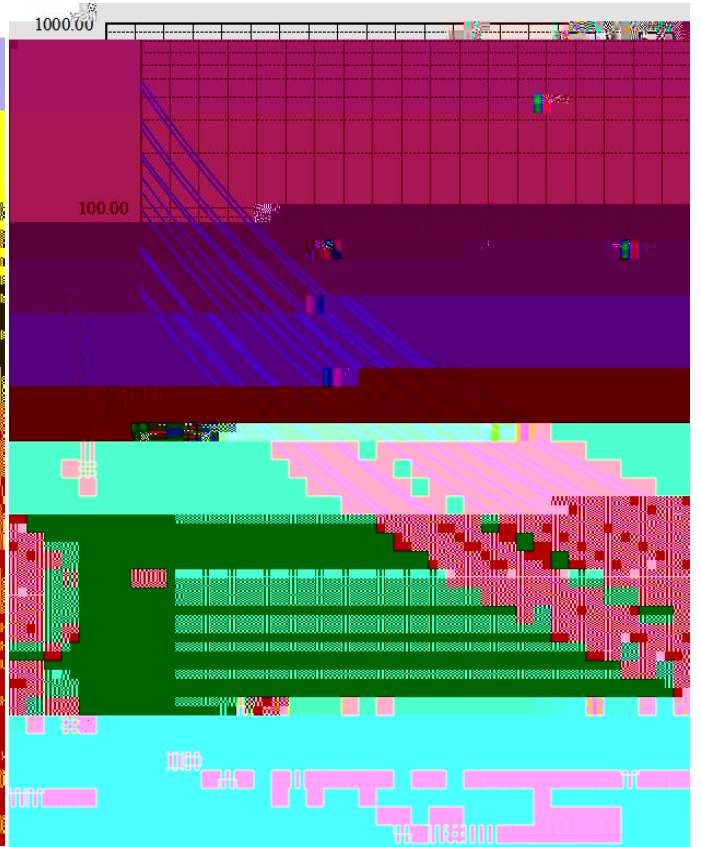
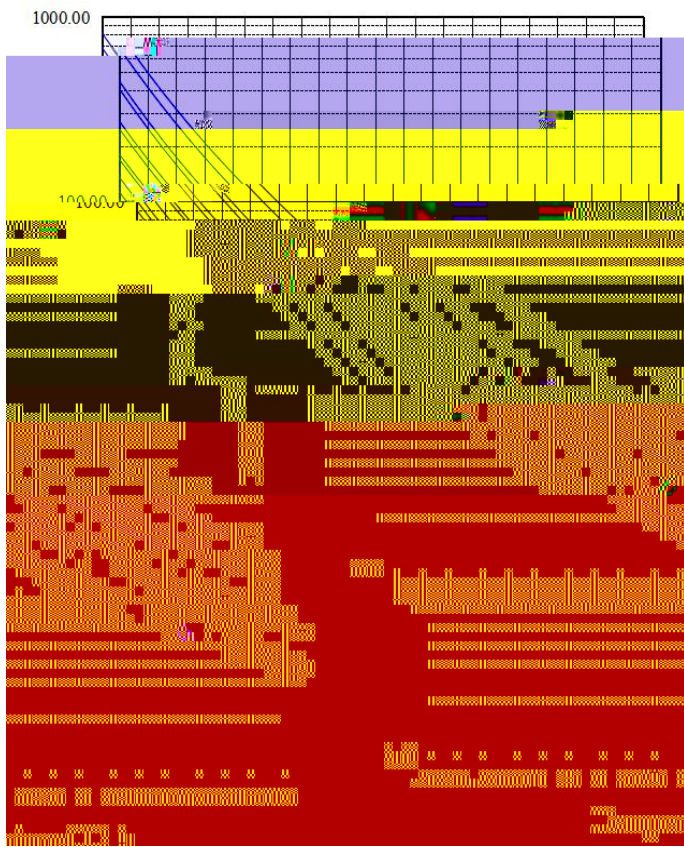

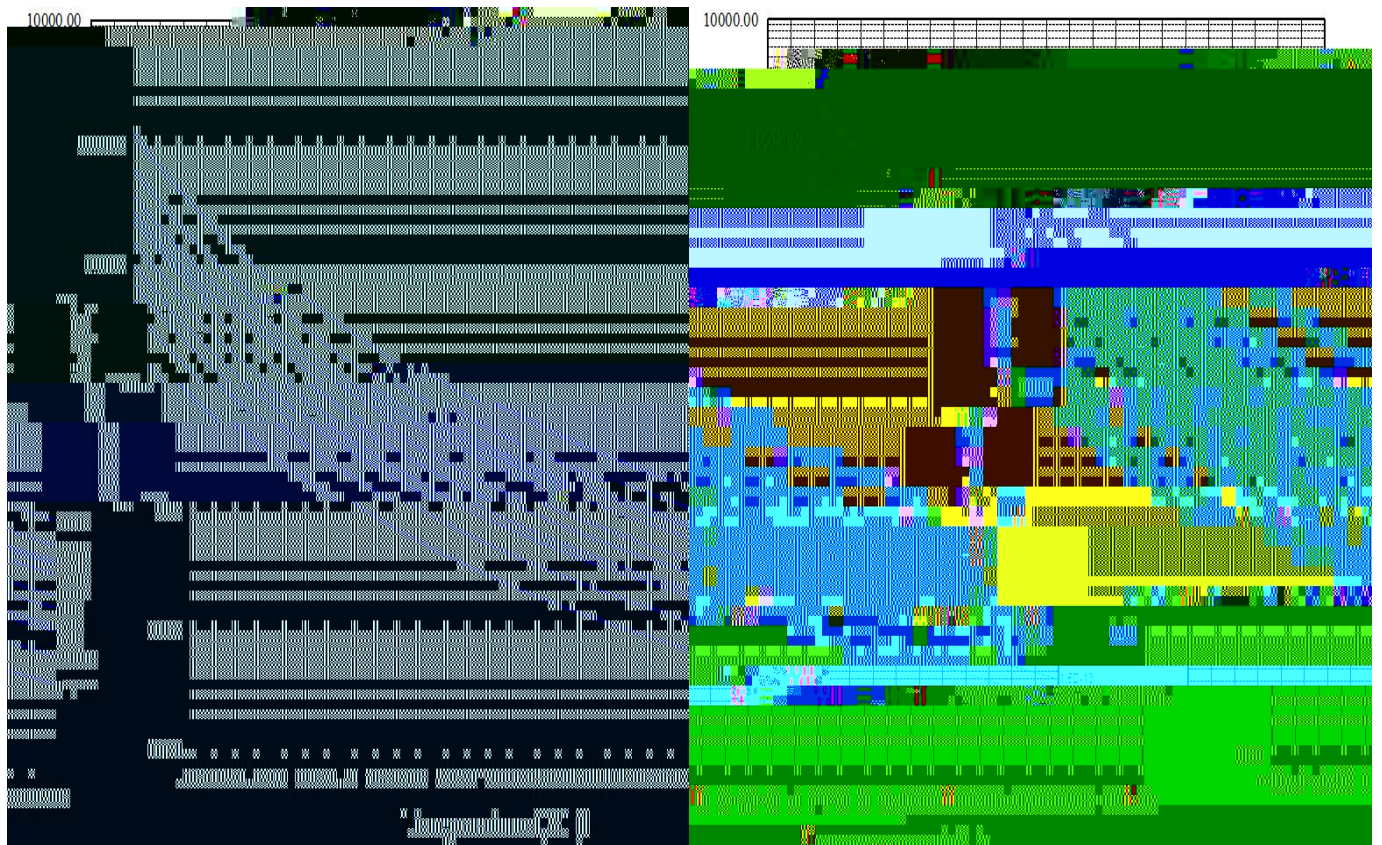
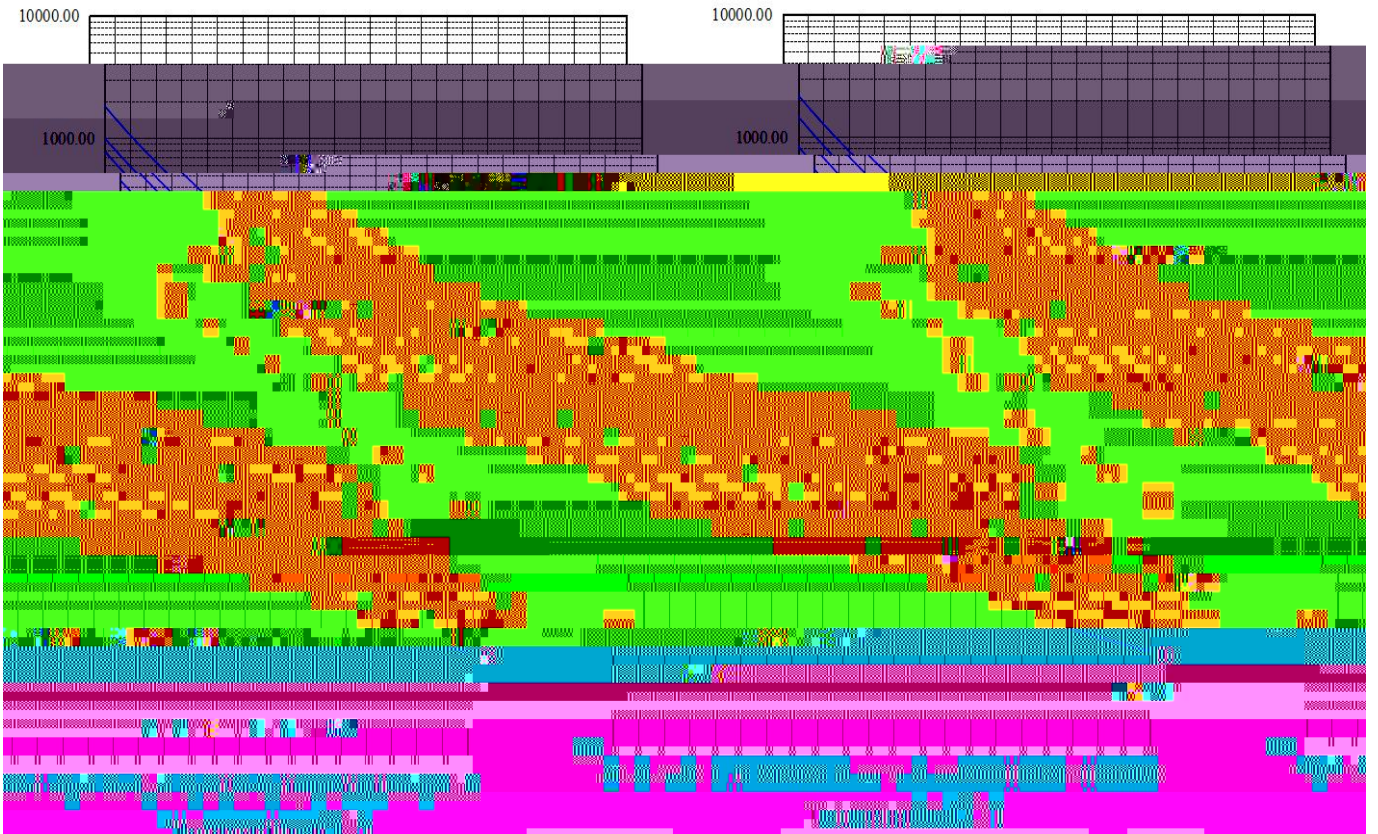

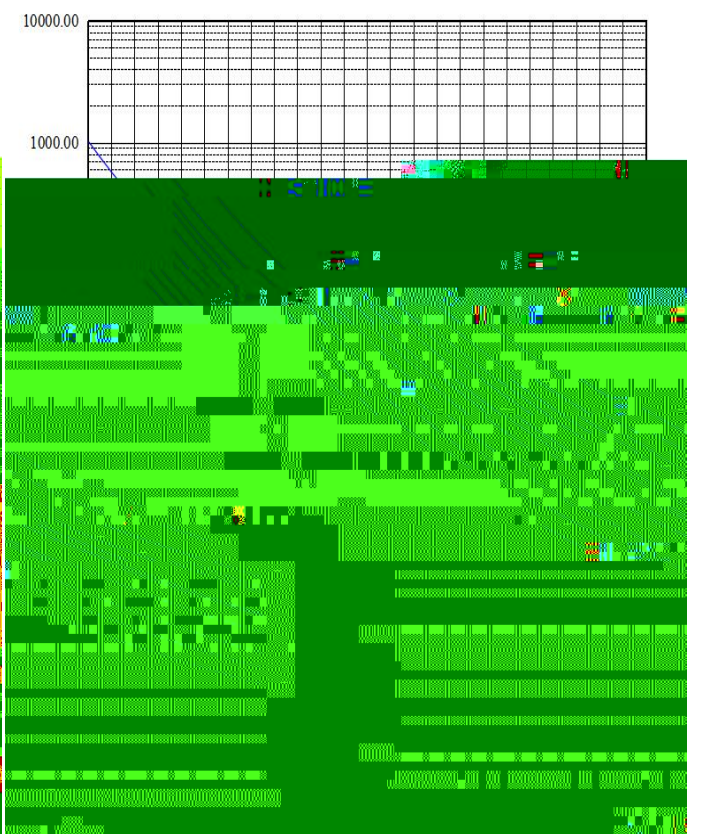
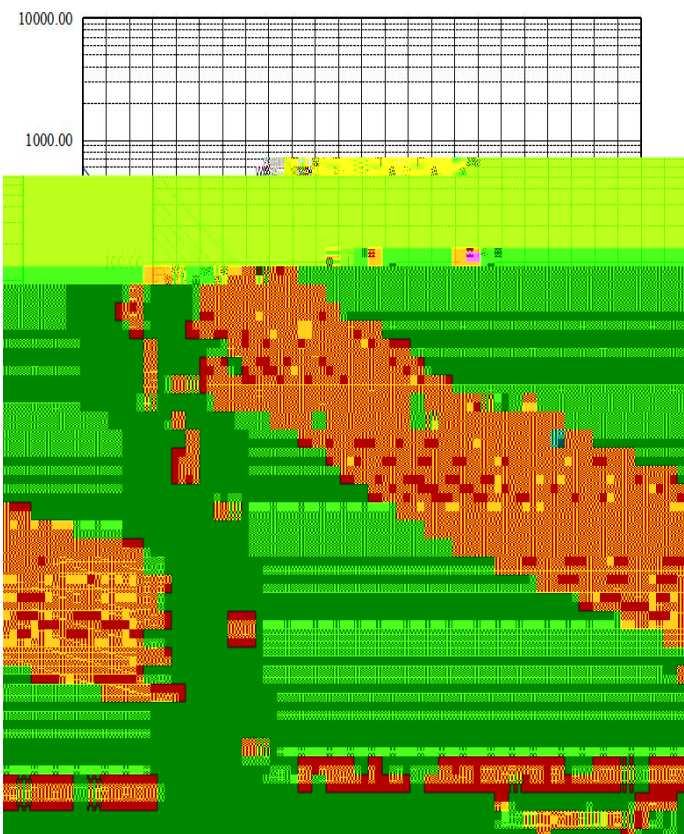
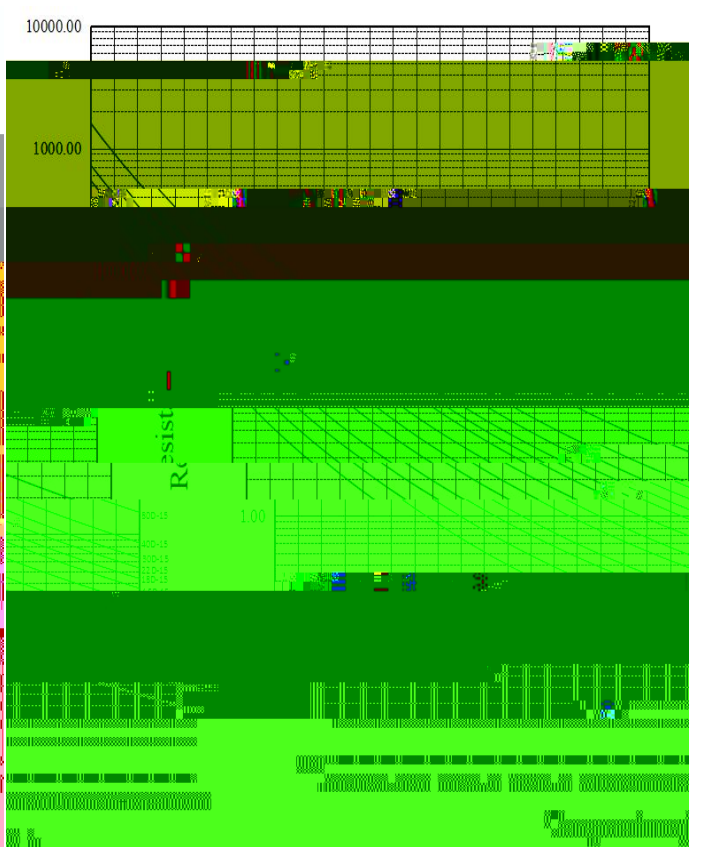
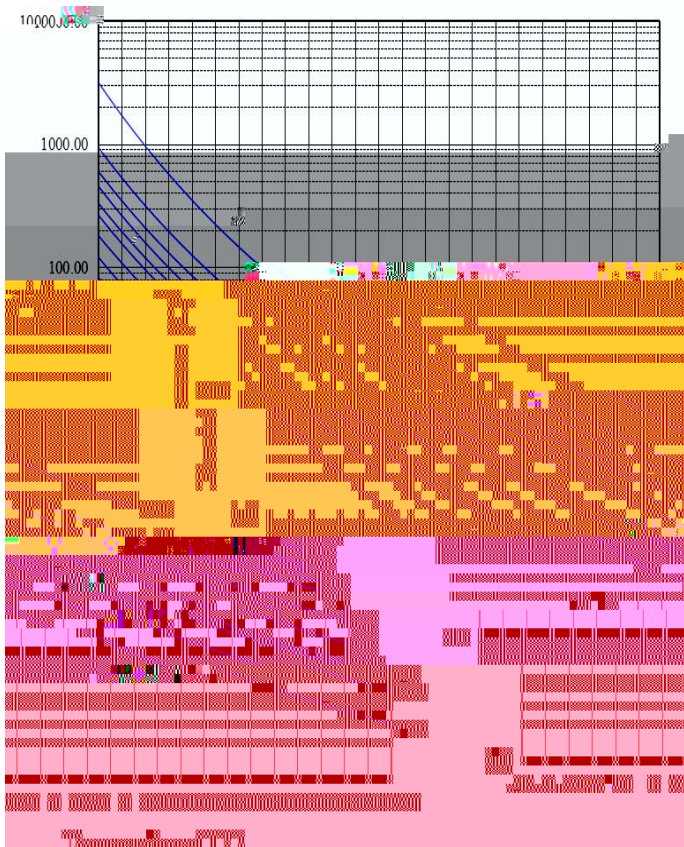

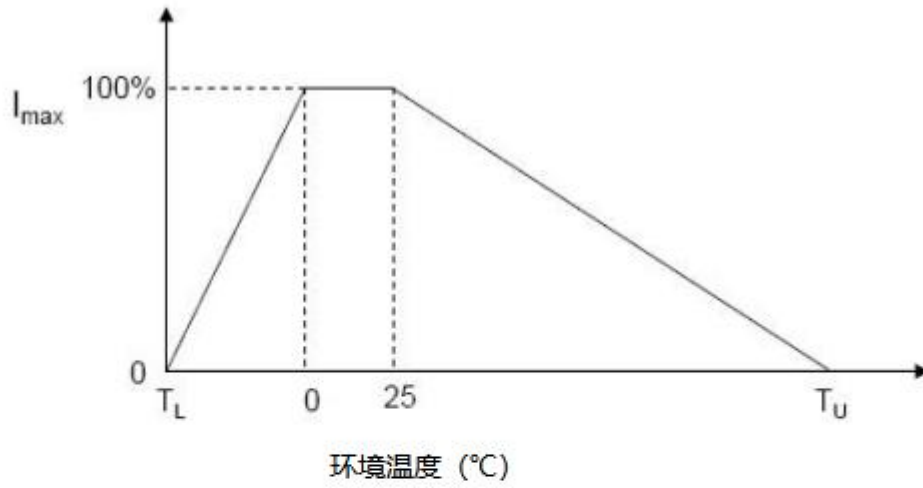

Ta: 工作时环境温度

Tu: 最大工作温度

T_L: 最小工作温度

$$\geq 25^{\circ}\text{C} : I_{Ta} = [1 - (Ta - 25) / (Tu - 25)] \times I_{max}$$

$$\leq 0^{\circ}\text{C} : I_{Ta} = (Ta - T_L) / (0 - T_L) \times I_{max}$$

